

**BENDIX/KING**  
LAA 300 SERIES  
BATTERY CHARGERS

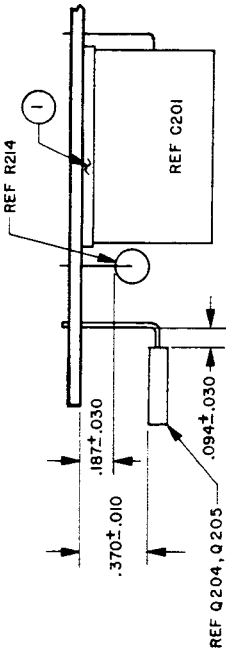

**ALTERNATE  
WIRING DETAIL**  
NOT TO SCALE

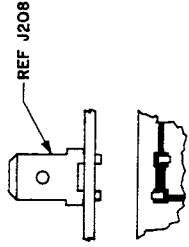

DETAIL A

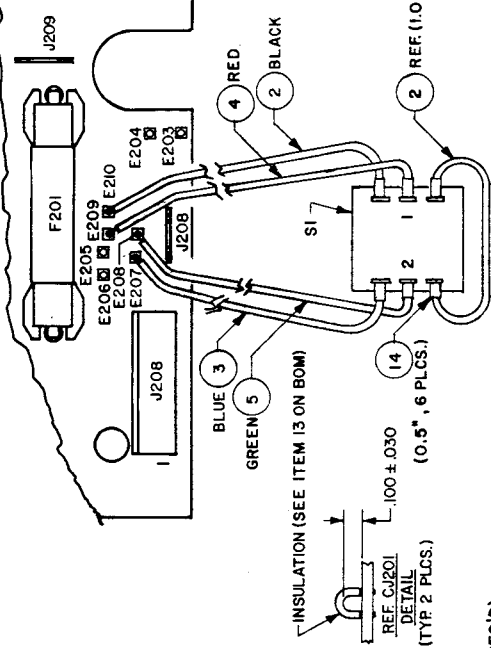

WIRE SWITCH S1 BY POSITION  
ORIENTED AS SHOWN.

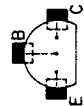

DETAIL B

- Q 207
- Q 202
- Q 203
- Q 201
- Q 206

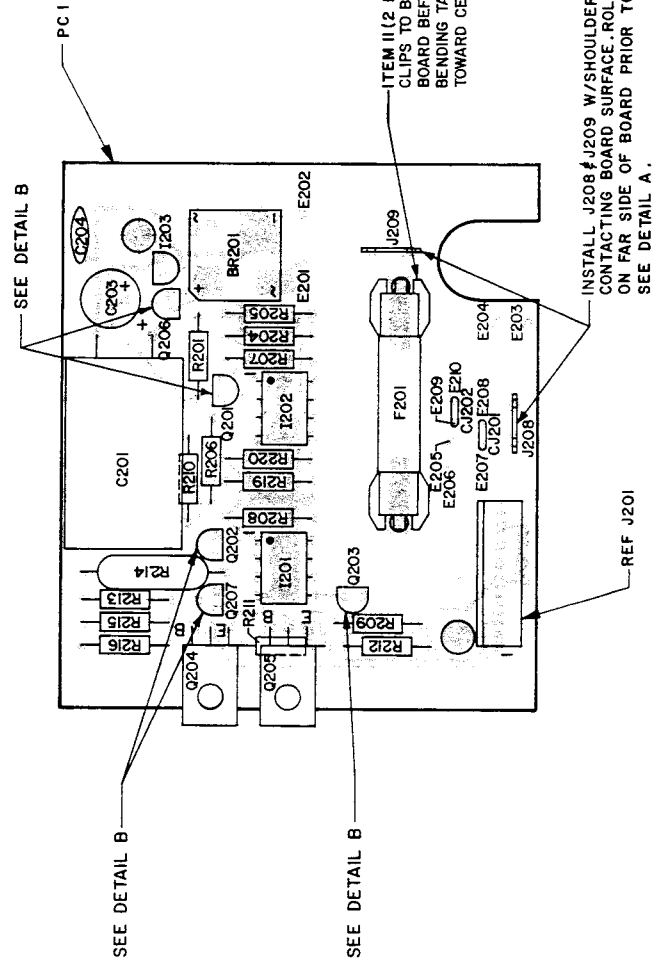

NOTES: UNLESS OTHERWISE SPECIFIED:  
1. BOARD SILKSCREENING NOT SHOWN FOR CLARITY.

FIGURE 6-7 CHARGER BOARD ASSEMBLY  
(DWG No 300-6886-20 Rev 3)

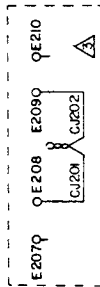
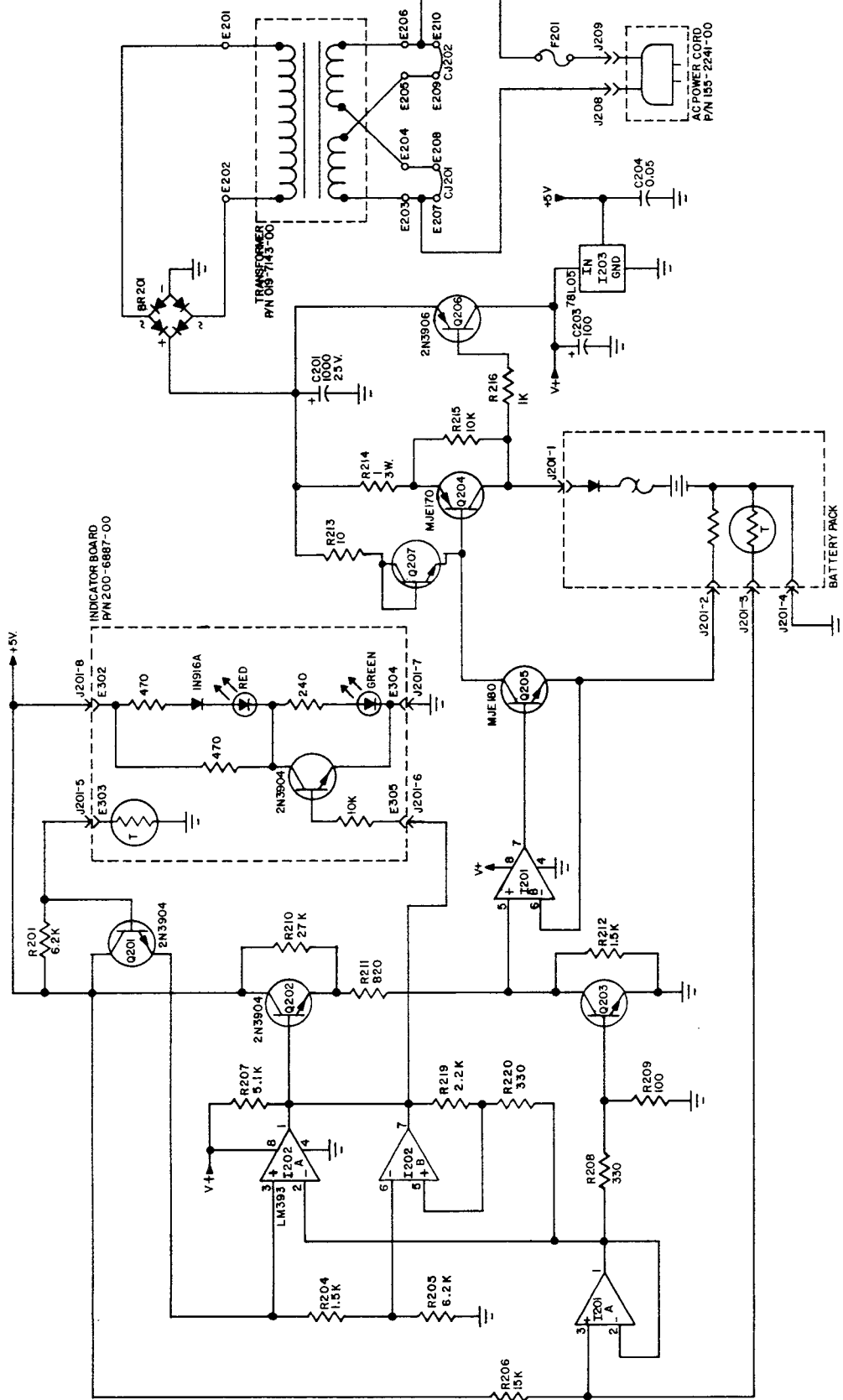

NOTES: UNLESS OTHERWISE SPECIFIED:  
 1. RESISTOR VALUES ARE IN OHMS./4W. ±5%.  
 2. CAPACITOR VALUES ARE IN MICROFARADS.  
 3. FOR 24VDC OPERATION, CUT CJ202 NEAR E210, TWIST THE ENDS TOGETHER AND SOLDER.